

INDEX

P/N	PAGE
10311(O-RING METRIC MALE FLAT SEAL).....	1
20211(METRIC FEMALE FLAT SEAT).....	4
20241(45°METRIC FEMALE FLAT).....	6
20291(90°METRIC FEMALE FLAT SEAT).....	7
10611(METRIC MALE DOUBLE USE FOR 60° CONE).....	9
20611(METRIC FEMALE 60° CONE).....	10
20641(45°METRIC FEMALE 60° CONE).....	11
20691(90°METRIC FEMALE 60° CONE).....	12
20111(METRIC FEMALE MULTISEAL).....	13
20141(45° METRIC FEMALE MULTISEAL).....	15
20191(90° METRIC FEMALE MULTISEAL).....	16
10711(GB METRIC MALE 74° CONE).....	17
20711(GB METRIC FEMALE 74° CONE SEAT).....	18
20741(45° GB METRIC FEMALE 74° CONE SEAT).....	20
20791(90° GB METRIC FEMALE 74° CONE SEAT).....	21
10711L(METRIC MALE 90° CONE SEAT).....	22
10411(METRIC MALE 24° CONE SEAT L.T.).....	23
20411(METRIC FEMALE 24° CONE O-RING L.T.).....	24
20441(45°METRIC FEMALE 24° CONE O-RING L.T.).....	26

20491(90°METRIC FEMALE 24° CONE O-RING L.T).....	27
20511(METRIC FEMALE 24° CONE O-RING H.T).....	29
20541(45° METRIC FEMALE 24° CONE O-RING H.T).....	30
20591(90° METRIC FEMALE 24° CONE O-RING H.T).....	32
20411C(METRIC FEMALE 24°MULTISEAL L.T).....	33
20491C(90° METRIC FEMALE 24°MULTISEAL L.T).....	34
20511C(METRIC FEMALE 24°MULTISEAL H.T).....	35
20541C(45° METRIC FEMALE 24°MULTISEAL H.T).....	36
20011(METRIC FEMALE WATERWASH INSERT).....	36
18611(JIS METRIC MALE 60° CONE SEAT).....	37
28611(JIS METRIC FEMALE 60° CONE SEAT).....	38
28641(45° JIS METRIC FEMALE 60° CONE SEAT).....	39
28691(90° JIS METRIC FEMALE 60° CONE SEAT).....	40
70011(METRIC BANJO DIN 7642).....	41
700M(METRIC BOLT DIN 7643).....	42
50011(METRIC STANDPIPE STRAIGHT DIN 2553).....	43
50041(45° METRIC STANDPIPE STRAIGHT DIN 2553).....	44
50091(90° METRIC STANDPIPE STRAIGHT DIN 2553).....	46

10311

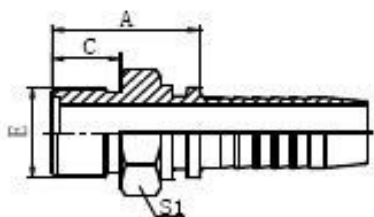

公制外螺纹平面 O 形圈密封

O-RING METRIC MALE FLAT SEAL REF.JB/T 988

代号 P/N	螺纹 E THREAD E	软管 HOSE BORE		尺寸 DIMENSIONS		
		公称内径 DN	标号 DASH	A	C	S1
10311-12-04	M12×1.25	6	04	22.5	10	14
10311-14-04	M14×1.5	6	04	23.5	11	17
10311-16-04	M16×1.5	6	04	23.5	11	17
10311-16-05	M16×1.5	8	04	23.5	11	17
10311-16-06	M16×1.5	10	06	23.5	11	17
10311-18-06	M18×1.5	10	06	23.5	11	19
10311-22-05	M22×1.5	8	05	27	12	22
10311-22-06	M22×1.5	10	06	26	12	22
10311-22-08	M22×1.5	12	08	26.5	12	22
10311-27-10	M27×1.5	16	10	31.5	13	27
10311-30-12	M30×1.5	20	12	33.5	14	32
10311-36-12	M36×2	20	12	35.5	16	38
10311-36-14	M36×2	22	14	35.5	16	38
10311-39-16	M39×2	25	16	39	16	41
10311-45-20	M45×2	32	20	44.5	20	46
10311-52-24	M52×2	40	24	47.5	22	55
10311-64-32	M64×2	50	32	52.5	27	65

Note: 1. For use with braided hoses.

2. If use with spiral hose, hose fitting series number is 10312-xx-xx

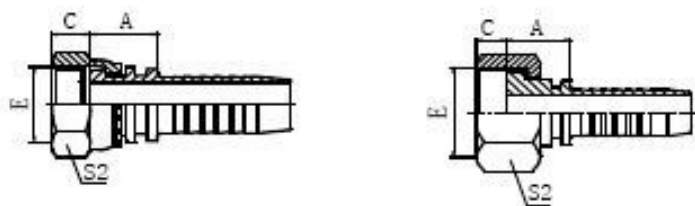

公制内螺纹平面

METRIC FEMALE FLAT
SEAT

20211

20211-T

代号 P/N	螺纹 E THREAD E	软管 HOSE BORE		尺寸 DIMENSIONS		
		公称内径 DN	标号 DASH	A	C	S1
20211-10-02	M10X1	4	02	14	6	14
20211-10-04	M10X1	6	04	14.5	6	14
20211-12-04	M12X1.25	6	04	15	8	17
20211-14-04	M14X1.5	6	04	15.5	8.5	19
20211-16-04	M16X1.5	6	04	16.5	8	22
20211-16-06	M16X1.5	10	06	16.5	8	22
20211-18-04T	M18X1.5	6	04	16	8	22
20211-18-05	M18X1.5	8	05	17.5	8	24
20211-18-06	M18X1.5	10	06	17.5	8	24
20211-18-08	M18X1.5	12	08	18	8	24
20211-20-06T	M20X1.5	10	06	16	10	24
20211-20-08	M20X1.5	12	08	18.5	10	27
20211-22-04T	M22X1.5	6	04	16	10	27
20211-22-05T	M22X1.5	8	05	16	10	27
20211-22-06T	M22X1.5	10	06	16	10	27
20211-22-08	M22X1.5	12	08	18.5	10	27
20211-22-10	M22X1.5	16	10	19.5	10	27
20211-24-06T	M24X1.5	10	06	16	11	30
20211-24-08T	M24X1.5	12	08	16.5	11	30

20211-24-10	M24X1.5	16	10	20.5	10.5	30
20211-27-05T	M27X1.5	8	05	18	10	32
20211-27-08T	M27X1.5	12	08	18.5	10	32
20211-27-10	M27X1.5	16	10	21.5	10	32
20211-27-12	M27X1.5	20	12	21.5	10	32
20211-30-08T	M30X1.5	12	08	17.5	11	36
20211-30-12	M30X1.5	20	12	21.5	11	36
20211-33-12T	M33X2	20	12	20	13	41
20211-33-14	M33X2	22	14	21.5	13	41
20211-33-16	M33X2	25	16	23	13	41
20211-36-06T	M36X2	10	06	20.5	13	41
20211-36-12T	M36X2	20	12	20	13	41
20211-36-14T	M36X2	22	14	20	13	41
20211-36-16	M36X2	25	16	23	13	41
20211-39-16T	M39X2	25	16	23.5	13	46
20211-39-20	M39X2	32	20	26	13	46
20211-42-12T	M42X2	20	12	22.5	15	50
20211-42-16T	M42X2	25	16	23.5	15	50
20211-42-20	M42X2	32	20	26	15	50
20211-45-16T	M45X2	25	16	24	15	55
20211-45-20T	M45X2	32	20	25	15	55
20211-52-12T	M52X2	20	12	23.5	17	60
20211-52-20T	M52X2	32	20	25	17	60
20211-52-24T	M52X2	40	24	25	17	60
20211-60-24T	M60X2	40	24	26	20	70
20211-60-28T	M60X2	45	28	26	20	70
20211-60-32	M60X2	50	32	27	20	70

20211-60-40	M60X2	64	40	30	20	70
20211-64-24T	M64X2	40	24	26	23	75
20211-64-32T	M64X2	50	32	26	23	75

Note: 1. For use with braided hoses.

2. If use with spiral hose, hose fitting series number is 20212-xx-xx

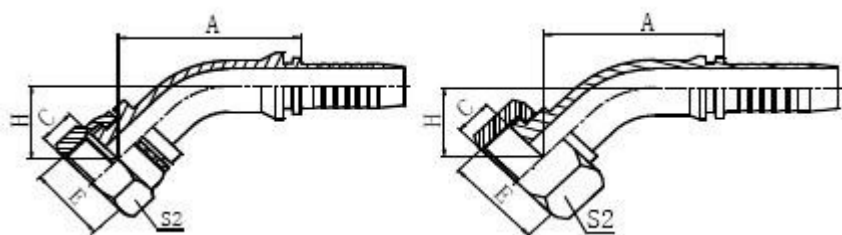

45°公制内螺纹平面密封

45 ° METRIC FEMALE FLAT

SEAT REF.GB/T

9065.3

20241

20241T

代号 P/N	螺纹 E THREAD E	软管 HOSE BORE		尺寸 DIMENSIONS			
		公称内径 DN	标号 DASH	A	C	H	S1
20241-14-04	M14X1.5	6	04	40.5	8.5	18.5	19
20241-14-05	M14X1.5	8	05	42.7	8.5	19.3	19
20241-16-05	M16X1.5	8	05	44.4	8.5	20	22
20241-18-06	M18X1.5	10	06	45.7	8	21.4	24
20241-22-08	M22X1.5	12	08	58.9	10	24	27
20241-27-10	M27X1.5	16	10	71.2	10	26.4	32
20241-30-12	M30X1.5	20	12	78.1	11	30	36
20241-36-12T	M36X2	20	12	75	13	27.5	41
20241-36-14T	M36X2	22	14	77.3	13	27	41

20241-36-16	M36X2	25	16	85.7	13	31.5	41
20241-39-16T	M39X2	25	16	83.9	13	29.7	46
20241-42-20	M42X2	32	20	97.3	15	36.6	50
20241-45-20T	M45X2	32	20	94.5	15	33.8	55
20241-52-20T	M52X2	32	20	94.5	17	33.8	60
20241-52-24T	M52X2	40	24	108.5	17	37.7	60
20241-60-28T	M60X2	45	28	118.7	20	43.6	70
20241-60-32	M60X2	50	32	132.1	20	49.1	70
20241-64-32T	M64X2	50	32	127.8	23	45.6	75

Note: 1. For use with braided hoses.

2. If use with spiral hose, hose fitting series number is 20242-xx-xx

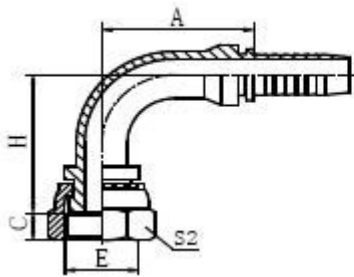

20291

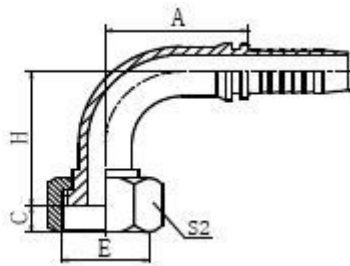

20291T

90°公制内螺纹平面密封

90 ° METRIC FEMALE FLAT SEAT

REF.GB/T 9065.3

代号 P/N	螺纹 E THREAD E	软管 HOSE BORE		尺寸 DIMENSIONS			
		公称内径 DN	标号 DASH	A	C	H	S1
20291-12-02	M12X1.25	4	02	26.5	8	30.5	17
20291-12-04	M12X1.25	6	04	30	8	33.5	17
20291-14-04	M14X1.5	6	04	30	8.5	34	19
20291-14-05	M14X1.5	8	05	33	8.5	37	19
20291-16-04	M16X1.5	6	04	30	8	35	22

20291-16-05	M16X1.5	8	05	34	8	38	22
20291-16-06	M16X1.5	10	06	35.3	8	40.3	22
20291-18-05	M18X1.5	8	05	33	8	39	24
20291-18-06	M18X1.5	10	06	35.75	8	41.3	24
20291-22-05T	M22X1.5	8	05	33	10	36.5	27
20291-22-06T	M22X1.5	10	06	35.3	10	38.8	27
20291-22-08	M22X1.5	12	08	41	10	48	27
20291-22-10	M22X1.5	16	10	57.5	10	53	27
20291-22-12	M22X1.5	20	12	65.5	10	62	27
20291-24-08T	M24X1.5	12	08	41	11	45.5	30
20291-27-04T	M27X1.5	6	04	30	10	35.5	32
20291-27-08T	M27X1.5	12	08	41	10	46	32
20291-27-10	M27X1.5	16	10	56.5	10	54	32
20291-30-12	M30X1.5	20	12	66.2	11	63.5	36
20291-33-14	M33X2	22	14	71.2	13	65	41
20291-36-12T	M36X2	20	12	65.5	13	60	41
20291-36-14T	M36X2	22	14	71.2	13	61	41
20291-36-16	M36X2	25	16	76.7	13	70	41
20291-39-16T	M39X2	25	16	76.7	13	67.5	46
20291-42-16T	M42X2	25	16	78	15	67.5	50
20291-42-20	M42X2	32	20	91.5	15	82.5	50
20291-45-20T	M45X2	32	20	91.5	15	78.5	55
20291-52-20T	M52X2	32	20	91.5	17	78.5	60
20291-52-24T	M52X2	40	24	109.4	17	92	60
20291-52-32	M52X2	50	32	131.75	17	118.3	60
20291-60-28T	M60X2	45	28	119.9	20	106.5	70
20291-64-32T	M64X2	50	32	130.95	23	113.3	75

Note: 1. For use with braided hoses.

2. If use with spiral hose, hose fitting series number is 20292-xx-xx

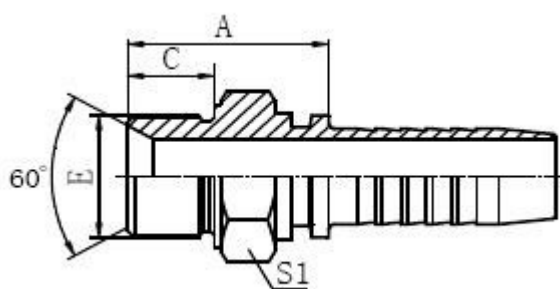

10611

公制外螺纹 60°内锥面或六角端面用组合垫密封
的双用接头

METRIC MALE DOUBLE USE FOR 60° CONE
SEAT OR BOUNDED SEAL

代号 P/N	螺纹 E THREAD E	软管 HOSE BORE		尺寸 DIMENSIONS		
		公称内径 DN	标号 DASH	A	C	S1
10611-14-04	M14X1.5	6	04	23.5	11	19
10611-16-05	M16X1.5	8	05	26.5	12	22
10611-18-06	M18X1.5	10	06	29.5	12	24
10611-22-06	M22X1.5	10	06	30.5	14	27
10611-22-08	M22X1.5	12	08	32	14	27
10611-24-10	M24X1.5	16	10	35	14	30

10611-26-10	M26X1.5	16	10	35	16	32
10611-30-12	M30X1.5	20	12	39	18	36
10611-38-16	M38X1.5	25	16	44	20	46
10611-45-20	M45X1.5	32	20	46	20	55
10611-52-24	M52X1.5	40	24	46	20	60

Note: 1. For use with braided hoses.

2. If use with spiral hose, hose fitting series number is 10612-xx-xx

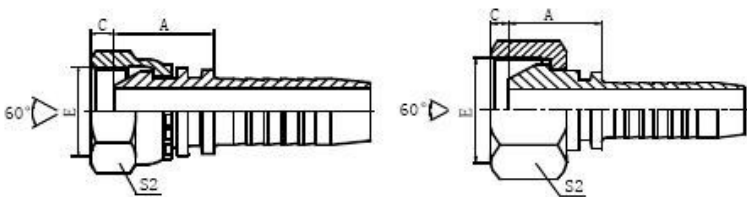

公制外螺纹 60°内锥面

METRIC FEMALE 60° CONE

20611

20611T

代号 P/N	螺纹 E THREAD E	软管 HOSE BORE		尺寸 DIMENSIONS			
		公称内径 DN	标号 DASH	A	C	S2	
20611-14-04	M14X1.5	6	04	18	5.5	19	
20611-16-05	M16X1.5	8	05	19	5.5	22	
20611-16-06	M16X1.5	10	06	19	5.5	22	
20611-18-06	M18X1.5	10	06	20	5.5	24	
20611-20-08	M20X1.5	12	08	22	6.5	27	
20611-22-08	M22X1.5	12	08	22.5	6	27	

20611-24-10	M24X1.5	16	10	24.5	6.5	30	
20611-26-10	M26X1.5	16	10	25.5	6	32	
20611-27-10	M27X1.5	16	10	25.5	6	32	
20611-30-10	M30X1.5	16	10	26.5	6	36	
20611-30-12	M30X1.5	20	12	26.5	6	36	
20611-36-16	M36X2	25	16	30	6.5	41	
20611-39-16T	M39X2	25	16	30	6.5	46	
20611-45-20T	M45X2	32	20	31	8.5	55	
20611-52-24T	M52X2	40	24	32	10	60	

Note: 1. For use with braided hoses.

2. If use with spiral hose, hose fitting series number is 20612-xx-xx

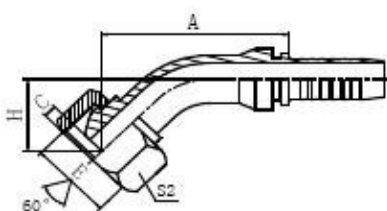
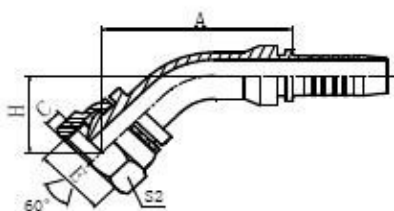

45°公制外螺纹 60°内锥面

45 ° METRIC FEMALE 60 °

CONE

20641

20641T

代号 P/N	螺纹 E THREAD E	软管 HOSE BORE		尺寸 DIMENSION ;			
		公称内径 DN	标号 DASH	A	C	H	S2
20641-14-04	M14X1.5	6	04	42.7	5.5	20.6	19
20641-16-05	M16X1.5	8	05	45.1	5.5	21.8	22
20641-18-06	M18X1.5	10	06	47.4	5.5	23.2	24

20641-22-08	M22X1.5	12	08	61.8	6	26.8	27
20641-27-10	M27X1.5	16	10	74	6	29.2	32
20641-30-12	M30X1.5	20	12	81.6	6	33.5	36
20641-36-14T	M36X2	22	14	81.9	6.5	31.6	41
20641-39-16T	M39X2	25	16	88.5	6.5	34.3	46
20641-45-20T	M45X2	32	20	99.1	8.5	38.4	55
20641-52-24T	M52X2	40	24	113.4	10	42.7	60

Note: 1. For use with braided hoses.

2. If use with spiral hose, hose fitting series number is 20642-xx-xx

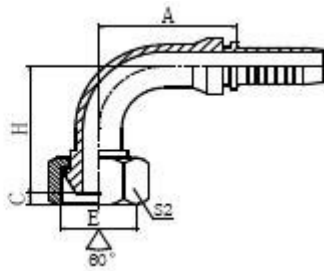
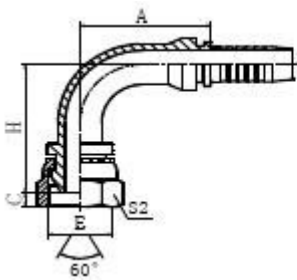

90°公制外螺纹 60°内锥面

90°METRIC FEMALE 60° CONE

20691

20691T

代号 P/N	螺纹 E THREAD E	软管 HOSE BORE		尺寸 DIMENSION ;			
		公称内径 DN	标号 DASH	A	C	H	S2
20691-14-04	M14X1.5	6	04	30	5.5	37	19
20691-16-05	M16X1.5	8	05	33	5.5	40.5	22
20691-18-06	M18X1.5	10	06	35.3	5.5	43.8	24

20691-22-08	M22X1.5	12	08	41	6	52	27
20691-27-10	M27X1.5	16	10	56.5	6	58	32
20691-30-12	M30X1.5	20	12	66.2	6	68.5	36
20691-36-16	M36X2	25	16	78	6.5	76.5	41
20691-36-14T	M36X2	22	14	71.2	6.5	67.5	41
20691-39-16T	M39X2	25	16	76.7	6.5	74	46
20691-45-20T	M45X2	32	20	91.5	8.5	85	55
20691-52-24T	M52X2	40	24	109.4	10	99	60

Note: 1. For use with braided hoses.

2. If use with spiral hose, hose fitting series number is 20692-xx-xx

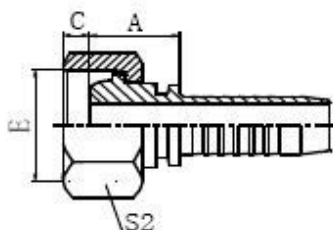
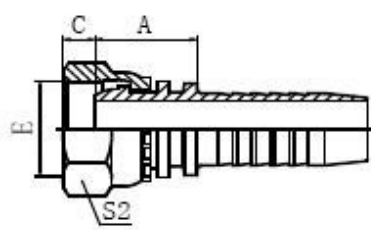

公制内螺纹球面

METRIC FEMALE
MULTISEAL

20111

20111T

代号 P/N	螺纹 E THREAD E	软管 HOSE BORE		尺寸 DIMENSIONS		
		公称内径 DN	标号 DASH	A	C	S1
20111-10-03	M10X1	5	03	18	2.5	14
20111-10-04	M10X1	6	04	18	2.5	14
20111-12-02	M12X1.5	4	02	18	4	17
20111-12-03	M12X1.5	5	03	18	4	17

20111-12-04	M12X1.5	6	04	18.5	4	17
20111-12-05	M12X1.5	8	05	18.5	4	17
20111-14-04	M14X1.5	6	04	19.5	4.5	19
20111-14-05	M14X1.5	8	05	19.5	4.5	19
20111-16-04	M16X1.5	6	04	19.5	4.5	22
20111-16-05	M16X1.5	8	05	20	4.5	22
20111-16-06	M16X1.5	10	06	20	4.5	22
20111-18-05	M18X1.5	8	05	21.5	4	24
20111-18-06	M18X1.5	10	06	21.5	4	24
20111-18-08	M18X1.5	12	08	22	4	24
20111-20-06T	M20X1.5	10	06	20.5	5.5	24
20111-20-08	M20X1.5	12	08	23	5.5	27
20111-22-06	M22X1.5	10	06	23	5	27
20111-22-08	M22X1.5	12	08	23.5	5	27
20111-22-10	M22X1.5	16	10	24.5	5	27
20111-24-08T	M24X1.5	12	08	22	5.5	30
20111-24-10	M24X1.5	16	10	26	5	30
20111-26-08T	M26X1.5	12	08	23	5.5	32
20111-26-10	M26X1.5	16	10	26	5.5	32
20111-26-12	M26X1.5	20	12	26	5.5	32
20111-27-08T	M27X1.5	12	08	23	5.5	32
20111-27-10	M27X1.5	16	10	26	5.5	32
20111-27-12	M27X1.5	20	12	26	5.5	32
20111-30-12	M30X1.5	20	12	26.5	6	36
20111-30-14	M30X1.5	22	14	26.5	6	36
20111-33-12T	M33X2	20	12	26	7	41
20111-33-14	M33X2	22	14	27.5	7	41

20111-36-12T	M36X2	20	12	26	7	41
20111-36-14T	M36X2	22	14	26	7	41
20111-36-16	M36X2	25	16	29	7	41
20111-39-14T	M39X2	22	14	28.5	7	46
20111-39-16T	M39X2	25	16	29.5	7	46
20111-39-20	M39X2	32	20	30.5	7	46
20111-42-16T	M42X2	25	16	30	8.5	50

Note: 1. For use with braided hoses.

2. If use with spiral hose, hose fitting series number is 20112-xx-xx

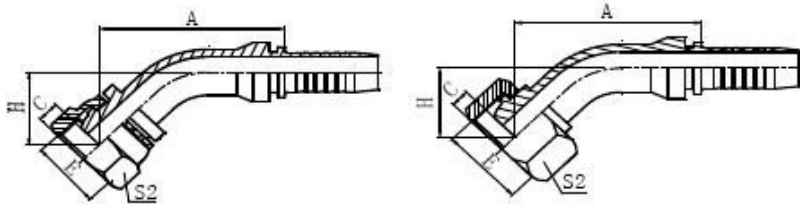

45° 公制内螺纹球面

45° METRIC FEMALE MULTISEAL

20141

20141T

代号 P/N	螺纹 E THREAD E	软管 HOSE BORE		尺寸 DIMENSION ;			
		公称内径 DN	标号 DASH	A	C	H	S2
20141-10-03	M10X1	5	03	41.1	2.5	20.7	14
20141-14-04	M14X1.5	6	04	43.4	4.5	21.3	19
20141-16-05	M16X1.5	8	05	45.8	4.5	22.5	22
20141-18-06	M18X1.5	10	06	48.5	4	24.2	24
20141-22-08	M22X1.5	12	08	62.1	5	27.2	27

20141-26-10	M26X1.5	16	10	74.4	5.5	29.6	32
20141-26-12	M26X1.5	20	12	80.6	5.5	33.2	32
20141-27-10	M27X1.5	16	10	74.4	5.5	29.6	32
20141-30-12	M30X1.5	20	12	80.9	6	33.5	36
20141-36-14T	M36X2	22	14	83	7	32.64	41
20141-39-16T	M39X2	25	16	88.2	7	33.95	46
20141-45-20T	M45X2	32	20	99.1	8.5	38.4	55
20141-52-24T	M52X2	40	24	114.1	9	43.4	60

Note: 1. For use with braided hoses.

2. If use with spiral hose, hose fitting series number is 20142-xx-xx

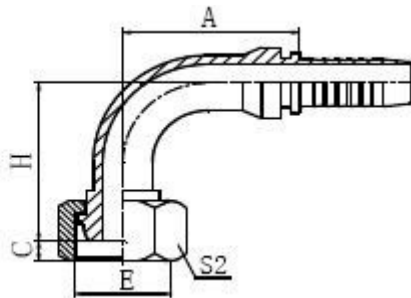
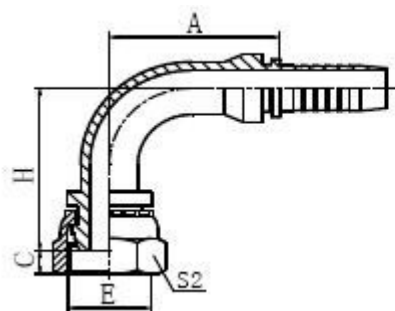

90° 公制内螺纹球面

90° METRIC FEMALE MULTISEAL

20191

20191T

代号 P/N	螺纹 E THREAD E	软管 HOSE BORE		尺寸 DIMENSIONS			
		公称内径 DN	标号 DASH	A	C	H	S2
20191-10-03	M10X1	5	03	27	2.5	35.5	14
20191-12-03	M12X1.5	5	03	26.5	4	34.5	17

20191-12-04	M12X1.5	6	04	30	4	37.5	17
20191-14-04	M14X1.5	6	04	30	4.5	38	19
20191-16-05	M16X1.5	8	05	33	4.5	41.5	22
20191-18-06	M18X1.5	10	06	35.3	4	45.3	24
20191-20-06T	M20X1.5	10	06	35.3	5.5	44.8	24
20191-20-08	M20X1.5	12	8	41	5.5	52	27
20191-22-08	M22X1.5	12	08	41	5	52.5	27
20191-26-10	M26X1.5	16	10	56.5	5.5	58.5	32
20191-27-10	M27X1.5	16	10	56.5	5.5	58.5	32
20191-30-12	M30X1.5	20	12	67.5	6	68.5	36
20191-36-12T	M36X2	20	12	65.5	7	68	41
20191-36-14T	M36X2	22	14	71.2	7	69	41
20191-39-16T	M39X2	25	16	76.7	7	73.5	46
20191-45-20T	M45X2	32	20	91.5	8.5	85	55
20191-52-24T	M52X2	40	24	109.4	9	100	60
20191-64-32T	M64X2	50	32	131.75	14	122.3	75

Note: 1. For use with braided hoses.

2. If use with spiral hose, hose fitting series number is 20192-xx-xx

10711 国标公制外螺纹 74°

外锥面

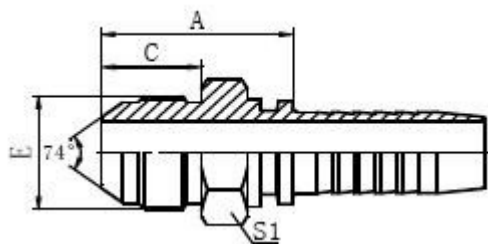

GB METRIC MALE 74° CONE

REF.GB/T 5623

代号 P/N	螺纹 E THREAD E	软管 HOSE BORE		尺寸 DIMENSIONS			
		公称内径 DN	标号 DASH	A	C	S1	
10711-10-02	M10X1	4	02	23	12.5	14	
10711-10-03	M10X1	5	03	23	12.5	14	
10711-12-03	M12X1.5	5	03	26.5	15.7	14	
10711-12-03C	M12X1.25	5	03	24.5	14	14	
10711-14-04	M14X1.5	6	04	30.5	18	17	
10711-14-06	M14X1.5	10	06	30.5	18	17	
10711-16-05	M16X1.5	8	05	31.5	19	17	
10711-16-06	M16X1.5	10	06	31.5	19	17	
10711-18-06	M18X1.5	10	06	31.5	19	19	
10711-22-08	M22X1.5	12	08	35	19.5	24	
10711-24-08	M24X1.5	12	08	37	20	27	
10711-27-10	M27X1.5	16	10	38.5	20.5	30	
10711-30-12	M30X1.5	20	12	42.5	23	32	
10711-30-12E	M30X2	20	12	45.5	26	32	
10711-33-12	M33X2	20	12	45	26	36	

10711-36-14	M36X2	22	14	45	26	38	
10711-39-16	M39X2	25	16	48	27.5	41	
10711-42-20	M42X2	32	20	52	28.5	46	
10711-45-20	M45X2	32	20	52	28.5	46	

Note: 1. For use with braided hoses.

2. If use with spiral hose, hose fitting series number is 10712-xx-xx

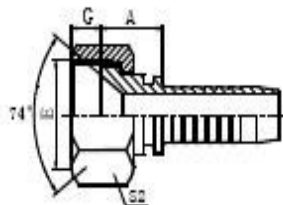
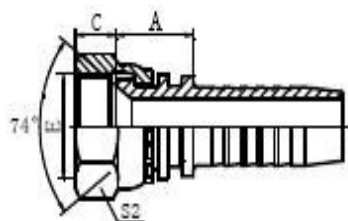

20711 国标公制内螺纹 74°

内锥面

GB METRIC FEMALE 74° CONE SEAT

REF.GB/T 9065.1

20711

20711-T

代号 P/N	螺纹 E THREAD E	软管 HOSE BORE		尺寸 DIMENSIONS		
		公称内径 DN	标号 DASH	A	C	S2
20711-10-02	M10X1	4	02	14	7.5	14
20711-10-04	M10X1	6	04	14.5	7.5	14
20711-12-02C	M12X1.25	4	02	14	9	17
20711-12-03C	M12X1.25	5	03	14	9	17
20711-12-05C	M12X1.25	8	05	14.5	9	17
20711-12-03	M12X1.5	5	03	14	10	17
20711-12-04	M12X1.5	6	04	14.5	10	17
20711-14-04	M14X1.5	6	04	15.5	8.5	19
20711-14-05	M14X1.5	8	05	15.5	8.5	19
20711-14-06	M14X1.5	10	06	15.5	8.5	19
20711-16-04	M16X1.5	6	04	16.5	8	22

20711-16-05	M16X1.5	8	05	16.5	8	22
20711-16-06	M16X1.5	10	06	16	8	22
20711-18-04T	M18X1.5	6	04	16	8	22
20711-18-05T	M18X1.5	8	05	16	8	22
20711-18-06	M18X1.5	10	06	17.5	10	24
20711-20-06T	M20X1.5	10	06	16	10	24
20711-20-08	M20X1.5	12	08	18.5	10	27
20711-22-05T	M22X1.5	8	05	16	10	27
20711-22-06T	M22X1.5	10	06	16	10	27
20711-22-08	M22X1.5	12	08	18.5	10	27
20711-22-10	M22X1.5	16	10	19.5	10	27
20711-22-12	M22X1.5	20	12	20	10	27
20711-24-06T	M24X1.5	10	06	16	11	30
20711-24-08T	M24X1.5	12	08	16.5	11	30
20711-27-08T	M27X1.5	12	08	18.5	11	32
20711-27-10	M27X1.5	16	10	21.5	11	32
20711-27-12	M27X1.5	20	12	21.5	11	32
20711-30-10T	M30X1.5	16	10	18.5	11	36
20711-30-12	M30X1.5	20	12	21.5	11	36
20711-33-10T	M33X2	16	10	20	13	41
20711-33-12T	M33X2	20	12	20	13	41
20711-33-14	M33X2	22	14	21.5	13	41
20711-33-16	M33X2	25	16	23	13	41
20711-36-12T	M36X2	20	12	20	14	41
20711-36-14T	M36X2	22	14	20	14	41
20711-36-16	M36X2	25	16	23	14	41
20711-39-16T	M39X2	25	16	23.5	14	46

20711-42-16T	M42X2	25	16	23.5	15	50
20711-42-20	M42X2	32	20	26	15	50
20711-45-20T	M45X2	32	20	25	15	55
20711-52-24T	M52X2	40	24	25	17	60
20711-60-32	M60X2	50	32	27	20	70
20711-64-32T	M64X2	50	32	26	23	75

Note: 1. For use with braided hoses.

2. If use with spiral hose, hose fitting series number is 20712-xx-xx

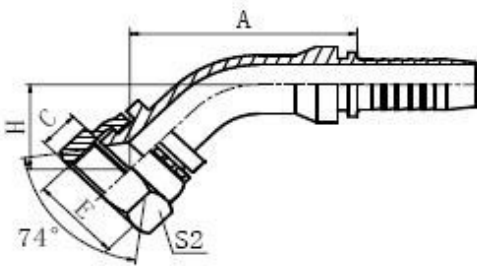

20741

45° 国标公制内螺纹 74°内锥面

45° GB METRIC FEMALE 74° CONE SEAT

REF.GB/T 9065.1

代号 P/N	螺纹 E THREAD E	软管 HOSE BORE		尺寸 DIMENSIONS			
		公称内径 DN	标号 DASH	A	C	H	S2
20741-14-04	M14X1.5	6	04	40.5	8.5	18.5	19
20741-16-05	M16X1.5	8	05	44.4	8	20	22
20741-18-06	M18X1.5	10	06	45.7	10	21.4	24
20741-22-08	M22X1.5	12	08	58.9	10	24	27
20741-27-10	M27X1.5	16	10	71.2	11	26.4	32
20741-30-12	M30X1.5	20	12	78.1	11	30	36
20741-33-12	M33X2	20	12	77.4	13	30	41

20741-33-16	M33X2	25	16	85	13	30.8	41
20741-36-14	M36X2	22	14	79.8	14	29.6	41
20741-36-16	M36X2	25	16	85.7	14	31.5	41
20741-39-16	M39X2	25	16	86.1	14	31.8	46
20741-45-20	M45X2	32	20	97	15	36.2	55
20741-52-24	M52X2	40	24	112.9	17	40.9	60

Note: 1. For use with braided hoses.

2. If use with spiral hose, hose fitting series number is 20742-xx-xx

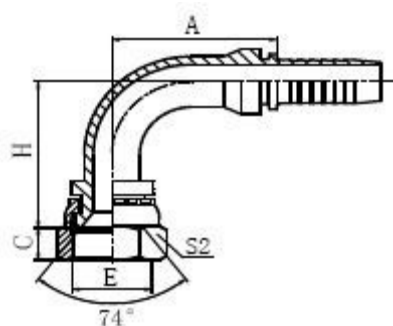

20791

90° 国标公制内螺纹 74°内锥面

90° GB METRIC FEMALE 74° CONE SEAT

REF.GB/T 9065.1

代号 P/N	螺纹 E THREAD E	软管 HOSE BORE		尺寸 DIMENSIONS			
		公称内径 DN	标号 DASH	A	C	H	S2
20791-12-04C	M12X1.25	6	04	30	9	33.5	17
20791-12-04	M12X1.5	6	04	30	10	33.5	17
20791-14-04	M14X1.5	6	04	30	8.5	34	19
20791-16-04	M16X1.5	6	04	30	8	35	22
20791-16-05	M16X1.5	8	05	34	8	38	22

20791-18-06	M18X1.5	10	06	35.3	10	41.3	24
20791-22-08	M22X1.5	12	08	41	10	48	27
20791-22-10	M22X1.5	16	10	56.5	10	52.5	27
20791-22-12	M22X1.5	20	12	65.5	10	62	27
20791-30-12	M30X1.5	20	12	66.2	11	63.5	36
20791-33-12	M33X2	20	12	65.5	13	63.5	41
20791-33-16	M33X2	25	16	76.7	13	69	41
20791-36-12	M36X2	20	12	65.5	14	63.5	41
20791-36-14	M36X2	22	14	71.2	14	64.5	41
20791-39-16	M39X2	25	16	76.7	14	70.5	46
20791-45-20	M45X2	32	20	91.5	15	83	55
20791-52-20	M52X2	32	20	93	17	84.5	60
20791-52-24	M52X2	40	24	110.7	17	96.5	60

Note: 1. For use with braided hoses.

2. If use with spiral hose, hose fitting series number is 20792-xx-xx

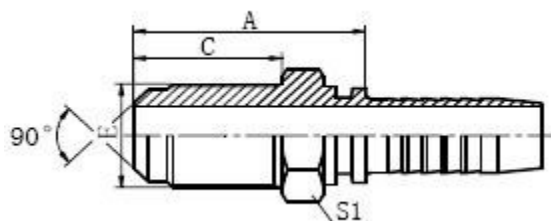

10811L 公制外螺纹 90°内

锥面

METRIC MALE 90° CONE SEAT

代号 P/N	螺纹 E THREAD E	软管 HOSE BORE		尺寸 DIMENSIONS			
		公称内径 DN	标号 DASH	A	C	S1	S2
10811L-12-04	M12X1.25	6	04	46	34	17	17
10811L-12-04A	M12X1	6	04	44.5	32.5	17	17
10811L-14-04	M14X1.5	6	04	46	34	17	19
10811L-14-06	M14X1.5	10	06	46.5	34	17	19
10811L-16-04	M16X1.5	6	04	46.5	34	19	22
10811L-16-06	M16X1.5	10	06	46.5	34	22	22
10811L-20-06	M20X1.5	10	06	57	40	27	27
10811L-20-08	M20X1.5	12	08	57.5	40	27	27
10811L-22-08	M22X1.5	12	08	62.5	45	27	27

Note: 1. For use with braided hoses.

2. If use with spiral hose, hose fitting series number is 10811L-xx-xx

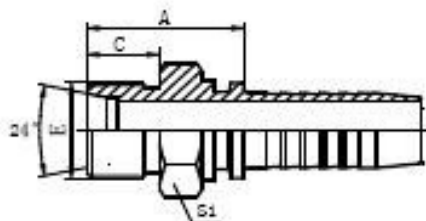

10411 公制外螺纹 24°内锥面轻列

METRIC MALE 24° CONE SEAT L.T.

ISO 8434-1-DIN 3861

代号 P/N	螺纹 E THREAD E	软管 HOSE BORE		管子外径 TUBE O.D	尺寸 DIMENSIONS		
		公称内径 DN	标号 DASH		A	C	S1
10411-12-04	M12X1.5	6	04	6	20.5	10	12
10411-14-04	M14X1.5	6	04	8	20.5	10	14
10411-14-05	M14X1.5	8	05	8	21.5	10	14
10411-16-04	M16X1.5	6	04	10	22.5	11	17
10411-16-05	M16X1.5	8	05	10	22.5	11	17
10411-16-06	M16X1.5	10	06	10	22.5	11	17
10411-16-08	M16X1.5	12	08	10	22	11	19
10411-18-05	M18X1.5	8	05	12	23.5	11	19
10411-18-06	M18X1.5	10	06	12	21.5	11	19
10411-22-06	M22X1.5	10	06	15	24.5	12	24
10411-22-08	M22X1.5	12	08	15	26	12	24
10411-26-08	M26X1.5	12	08	18	26.5	12	27
10411-26-10	M26X1.5	16	10	18	27	12	27
10411-30-08	M30X2	12	08	22	28	14	32

Note: 1. For use with braided hoses.

2. If use with spiral hose, hose fitting series number is 10412-xx-xx

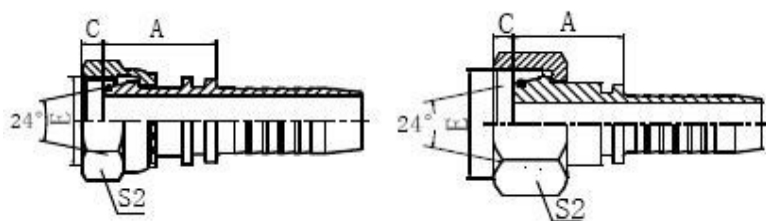

公制内螺纹 24°锥带 O 形圈轻系列

METRIC FEMALE 24° CONE O-RING L.T

ISO 12151-2--DIN 3865

20411

20411T

代号 P/N	螺纹 E THREAD E	软管 HOSE BORE		管子外径 TUBE OD	O 形圈 O RING	尺寸 DIMENSIONS		
		公称内径 DN	标号 DASH			A	C	S2
20411-12-04	M12X1.5	6	04	6	4X1.5	26	1	17
20411-14-04	M14X1.5	6	04	8	6X1.5	27.5	2	19
20411-14-06	M14X1.5	10	06	8	6X1.5	27.5	2	19
20411-16-04	M16X1.5	6	04	10	7.5X1.5	28	2	22
20411-16-05	M16X1.5	8	05	10	7.5X1.5	28	2	22
20411-16-06	M16X1.5	10	06	10	7.5X1.5	28	2	22
20411-18-05T	M18X1.5	8	05	12	9.5X1.5	27.5	1.8	22
20411-18-06	M18X1.5	10	06	12	9.5X1.5	29	2.5	24
20411-22-05T	M22X1.5	8	05	15	12.0X2.0	29.5	2.1	27
20411-22-06	M22X1.5	10	06	15	12.0X2.0	31.5	2.5	27
20411-22-06T	M22X1.5	10	06	15	12.0X2.0	29	2.5	27

20411-22-08	M22X1.5	12	08	15	12.0X2.0	32	2.5	27
20411-26-10	M26X1.5	16	10	18	15.0X2.0	35	2.5	32
20411-26-12	M26X1.5	20	12	18	15.0X2.0	35	2.5	32
20411-27-10	M27X1.5	16	10	18	15.0X2.0	35	2.5	32
20411-27-12	M27X1.5	20	12	18	15.0X2.0	35	2.5	32
20411-30-10T	M30X2	16	10	22	20.0X2.0	35	4	36
20411-30-12	M30X2	20	12	22	20.0X2.0	38	4	36
20411-36-14T	M36X2	22	14	28	26.0X2.0	36	4	41
20411-36-16	M36X2	25	16	28	26.0X2.0	39.5	4	41
20411-36-20	M36X2	32	20	28	26.0X2.0	40	4	41
20411-45-16T	M45X2	25	16	35	32.0X2.5	41	5	55
20411-45-20T	M45X2	32	20	35	32.0X2.5	42	5	55
20411-52-20T	M52X2	32	20	42	38.0X2.5	44	5.5	60
20411-52-24T	M52X2	40	24	42	38.0X2.5	44	5.5	60

Note: 1. For use with braided hoses.

2. If use with spiral hose, hose fitting series number is 20412-xx-xx

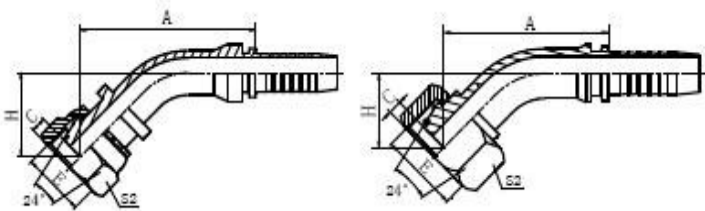

45°公制内螺纹 24°锥带 O 形圈轻系列

45°METRIC FEMALE 24° CONE O-RING L.T

ISO 12151-2--DIN 3865

20441

20441-T

代号 P/N	螺纹 E THREAD E	软管 HOSE BORE		管子外径 TUBE OD	O 形圈 O RING	尺寸 DIMENSIONS			
		公称内径 DN	标号 DASH			A	C	H	S2
20441-14-04	M14X1.5	6	04	8	6X1.5	49	2	27	19
20441-16-04	M16X1.5	6	04	10	7.5X1.5	49.4	2	27.3	22
20441-16-06	M16X1.5	10	06	10	7.5X1.5	53.4	2	29.2	22
20441-18-05T	M18X1.5	8	05	12	9.5X1.5	46.2	2.5	22.9	22
20441-18-06	M18X1.5	10	06	12	9.5X1.5	54.2	2.5	29.9	24
20441-22-05T	M22X1.5	8	05	15	12.0X2.0	48.3	2.5	25	27
20441-22-06T	M22X1.5	10	06	15	12.0X2.0	50.4	2.5	25.7	27
20441-22-08	M22X1.5	12	08	15	12.0X2.0	68.1	2.5	33.2	27
20441-26-10	M26X1.5	16	10	18	15.0X2.0	80.7	2.5	35.9	32

20441-26-12	M26X1.5	20	12	18	15.0X2.0	86.9	2.5	39.5	32
20441-27-12	M27X1.5	20	12	18	15.0X2.0	86.9	2.5	39.5	32
20441-30-10T	M30X2	16	10	22	20.0X2.0	75.1	4	30.3	36
20441-30-12	M30X2	20	12	22	20.0X2.0	89.1	4	41.7	36
20441-36-12T	M36X2	20	12	28	26.0X2.0	82	4	33.9	41
20441-36-16	M36X2	25	16	28	26.0X2.0	97	4	42.8	41
20441-52-20T	M52X2	32	20	42	38.0X2.5	102.6	5.5	41.9	60
20441-52-24T	M52X2	40	24	42	38.0X2.5	116.6	5.5	45.8	60

Note: 1. For use with braided hoses.

2. If use with spiral hose, hose fitting series number is 20442-xx-xx

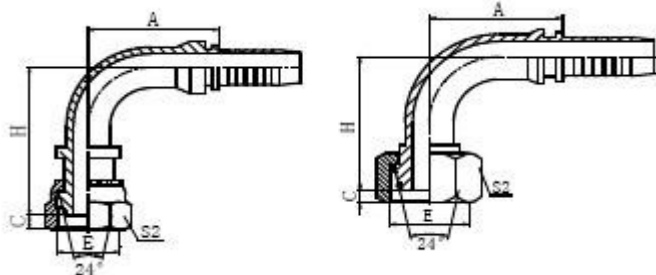

90°公制内螺纹 24°锥带 O 形圈轻系列

90°METRIC FEMALE 24° CONE O-RING L.T

ISO 12151-2--DIN 3865

20491

20491-T

代号 P/N	螺纹 E THREAD E	软管 HOSE BORE		管子外径 TUBE OD	O 形圈 O RING	尺寸 DIMENSIONS			
		公称内径 DN	标号 DASH			A	C	H	S2
20491-12-03	M12X1.5	5	03	6	4.0X1.5	26.5	1	41.5	17
20491-12-04	M12X1.5	6	04	6	4.0X1.5	30	1	44.5	17
20491-14-04	M14X1.5	6	04	8	6.0X1.5	30	2	46	19
20491-16-04	M16X1.5	6	04	10	7.5X1.5	30	2	46.5	22

20491-16-05	M16X1.5	8	05	10	7.5X1.5	33	2	49.5	22
20491-16-06	M16X1.5	10	06	10	7.5X1.5	35.3	2	51.8	22
20491-18-05T	M18X1.5	8	05	12	9.5X1.5	33	2.5	42	22
20491-18-06	M18X1.5	10	06	12	9.5X1.5	35.3	2.5	53.3	24
20491-22-05T	M22X1.5	8	05	15	12.0X2.0	33	2.5	45	27
20491-22-06T	M22X1.5	10	06	15	12.0X2.0	35.3	2.5	47.3	27
20491-22-08	M22X1.5	12	08	15	12.0X2.0	41	2.5	61	27
20491-22-12	M22X1.5	20	12	15	12.0X2.0	65.5	2.5	75	27
20491-26-10	M26X1.5	16	10	18	15.0X2.0	56.5	2.5	67.5	32
20491-26-12	M26X1.5	20	12	18	15.0X2.0	65.5	2.5	77	32
20491-27-10	M27X1.5	16	10	18	15.0X2.0	56.5	2.5	67.5	32
20491-27-12	M27X1.5	20	12	18	15.0X2.0	65.5	2.5	77	32
20491-30-16	M30X2	25	16	22	15.0X2.0	76.7	4	86.5	36
20491-30-08T	M30X2	12	08	22	20.0X2.0	41	4	55	36
20491-30-10T	M30X2	16	10	22	20.0X2.0	56.5	4	57.2	36
20491-30-12	M30X2	20	12	22	20.0X2.0	65.5	4	80	36
20491-36-12T	M36X2	20	12	28	26.0X2.0	65.5	4	69	41
20491-36-14T	M36X2	22	14	28	26.0X2.0	71.2	4	70	41
20491-36-16	M36X2	25	16	28	26.0X2.0	76.7	4	86	41
20491-45-16T	M45X2	25	16	35	32.0X2.5	76.7	5	75	55
20491-45-20T	M45X2	32	20	35	32.0X2.5	91.5	5	88.5	55
20491-52-20T	M52X2	32	20	42	38.0X2.5	93	5.5	87	60
20491-52-24T	M52X2	40	24	42	38.0X2.5	109.4	5.5	103.5	60

Note: 1. For use with braided hoses.

2. If use with spiral hose, hose fitting series number is 20492-xx-xx

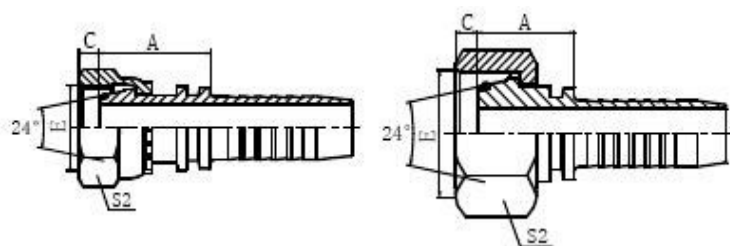

公制内螺纹 24°锥带 O 形圈重系列

METRIC FEMALE 24° CONE O-RING H.T

ISO 12151-2--DIN 3865

20511

20511-T

代号 P/N	螺纹 E THREAD E	软管 HOSE BORE		管子外径 TUBE OD	O 形圈 O RING	尺寸 DIMENSIONS			
		公称内径 DN	标号 DASH			A	C	S2	
20511-16-04	M16X1.5	6	04	8	6.0X1.5	29	1.5	22	
20511-16-05	M16X1.5	8	05	8	6.0X1.5	29	1.5	22	
20511-18-04T	M18X1.5	6	04	10	7.5X1.5	26.5	2	22	
20511-18-06	M18X1.5	10	06	10	7.5X1.5	29	2	24	
20511-20-04T	M20X1.5	6	04	12	9.5X1.5	28.5	2.5	24	
20511-20-05T	M20X1.5	8	05	12	9.5X1.5	28.5	2.5	24	
20511-20-06T	M20X1.5	10	06	12	9.5X1.5	28.5	2.5	24	
20511-20-08	M20X1.5	12	08	12	9.5X1.5	31.5	2.5	27	
20511-22-06T	M22X1.5	10	06	14	10.0X2.0	28.5	2.5	27	
20511-22-08	M22X1.5	12	08	14	10.0X2.0	31.5	2.5	27	
20511-24-06T	M24X1.5	10	06	16	12.0X2.0	28.5	2.5	30	
20511-24-08T	M24X1.5	12	08	16	12.0X2.0	30	3	30	
20511-30-08T	M30X2	12	08	20	16.3X2.4	35	3	36	
20511-30-10T	M30X2	16	10	20	16.3X2.4	36	3	36	
20511-30-12	M30X2	20	12	20	16.3X2.4	39	3	36	
20511-30-14	M30X2	22	14	20	16.3X2.4	39	3	36	
20511-36-12T	M36X2	20	12	25	20.3X2.4	36	3	41	

20511-36-14T	M36X2	22	14	25	20.3X2.4	36	3	41	
20511-36-16	M36X2	25	16	25	20.3X2.4	40.5	3	41	
20511-42-12T	M42X2	20	12	30	25.3X2.4	40	5	50	
20511-42-16T	M42X2	25	16	30	25.3X2.4	41	5	50	
20511-42-20	M42X2	32	20	30	25.3X2.4	46	5	50	
20511-52-20T	M52X2	32	20	38	33.3X2.4	44	6.5	60	
20511-52-24T	M52X2	40	24	38	33.3X2.4	44	6.5	60	

Note: 1. For use with braided hoses.

2. If use with spiral hose, hose fitting series number is 20512-xx-xx

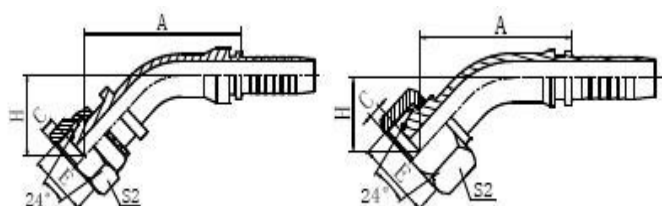

45° 公制内螺纹 24°锥带 O 形圈重系列

45° METRIC FEMALE 24° CONE O-RING H.T

ISO 12151-2--DIN 3865

20541

20541T

代号 P/N	螺纹 E THREAD E	软管 HOSE BORE		管子外径 TUBE OD	O 形圈 O RING	尺寸 DIMENSIONS			
		公称内径 DN	标号 DASH			A	C	H	S2
20541-16-04	M16X1.5	6	04	8	6.0X1.5	50.4	1.5	28.3	22
20541-16-05	M16X1.5	8	05	8	6.0X1.5	52.2	1.5	28.9	22
20541-18-04T	M18X1.5	6	04	10	7.5X1.5	43.4	2	21.3	22
20541-18-06	M18X1.5	10	06	10	7.5X1.5	54.3	2	29.6	24
20541-20-04T	M20X1.5	6	04	12	9.0X1.5	45.5	2.5	23.4	24
20541-20-05T	M20X1.5	8	05	12	9.0X1.5	48.1	2.5	24.3	24

20541-20-06T	M20X1.5	10	06	12	9.0X1.5	49.7	2.5	25	24
20541-20-08	M20X1.5	12	08	12	9.0X1.5	67.8	2.5	32.8	27
20541-22-06T	M22X1.5	10	06	14	10.0X2.0	49.6	2.5	25.3	27
20541-22-08	M22X1.5	12	08	14	10.0X2.0	68.1	2.5	33.2	27
20541-24-08T	M24X1.5	12	08	16	12.0X2.0	62.5	3	27.5	30
20541-24-10	M24X1.5	16	10	16	12.0X2.0	80.7	2.5	35.9	30
20541-30-10T	M30X2	16	10	20	16.3X2.4	75.8	3	31	36
20541-30-12	M30X2	20	12	20	16.3X2.4	90.5	3	42.4	36
20541-36-12T	M36X2	20	12	25	20.3X2.4	82.7	3	34.6	41
20541-36-14T	M36X2	22	14	25	20.3X2.4	84.4	3	34	41
20541-36-16	M36X2	25	16	25	20.3X2.4	99.7	3	44.2	41
20541-42-16T	M42X2	25	16	30	25.3X2.4	92.3	5	36.8	50
20541-42-20	M42X2	32	20	30	25.3X2.4	110.8	5	50	50
20541-52-20T	M52X2	32	20	38	33.3X2.4	103.4	6.5	41.2	60
20541-52-24T	M52X2	40	24	38	33.3X2.4	115.9	6.5	45.1	60

Note: 1. For use with braided hoses.

2. If use with spiral hose, hose fitting series number is 20542-xx-xx

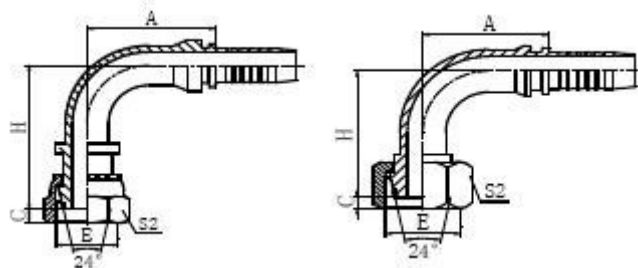

90° 公制内螺纹 24°锥带 O 形圈重系列

90° METRIC FEMALE 24° CONE O-RING H.T

ISO 12151-2--DIN 3865

20591

20591T

代号 P/N	螺纹 E THREAD E	软管 HOSE BORE		管子外径 TUBE OD	O 形圈 O RING	尺寸 DIMENSIONS			
		公称内径 DN	标号 DASH			A	C	H	S2
20591-16-04	M16X1.5	6	04	8	6.5X1.5	30	1.5	48	22
20591-16-05	M16X1.5	8	05	8	6.5X1.5	33	1.5	51	22
20591-18-04T	M18X1.5	6	04	10	8.5X1.5	30	2	39.5	22
20591-18-05T	M18X1.5	8	05	10	8.5X1.5	33	2	41.5	22
20591-18-06	M18X1.5	10	06	10	8.5X1.5	35.3	2	52.8	24
20591-20-04T	M20X1.5	6	04	12	10.5X1.5	30	2.5	41	24
20591-20-05T	M20X1.5	8	05	12	10.5X1.5	33.5	2.5	44	24
20591-20-06T	M20X1.5	10	06	12	10.5X1.5	35.8	2.5	46.3	24
20591-20-08	M20X1.5	12	08	12	10.5X1.5	41	2.5	61	27
20591-22-06T	M22X1.5	10	06	14	12.0X2.0	35.3	2.5	46.8	27
20591-22-08	M22X1.5	12	08	14	12.0X2.0	41	2.5	61	27
20591-24-06T	M24X1.5	10	06	16	13.0X2.0	35.3	3	46.3	30
20591-24-08T	M24X1.5	12	08	16	13.0X2.0	41	3	53	30

20591-24-10	M24X1.5	16	10	16	13.0X2.0	56.5	2.5	67.5	30
20591-30-10T	M30X2	16	10	20	16.3X2.4	56.5	3	60.5	36
20591-30-12	M30X2	20	12	20	16.3X2.4	65.5	3	81	36
20591-36-12T	M36X2	20	12	25	20.3X2.4	66.2	3	70	41
20591-36-14T	M36X2	22	14	25	20.3X2.4	71.2	3	71	41
20591-42-16T	M42X2	25	16	30	25.3X2.4	78	5	77.5	50
20591-42-20	M42X2	32	20	30	25.3X2.4	91.5	5	101.5	50
20591-52-20T	M52X2	32	20	38	33.3X2.4	93	6.5	89	60
20591-52-24T	M52X2	40	24	38	33.3X2.4	109.4	6.5	102.5	60

Note: 1. For use with braided hoses.

2. If use with spiral hose, hose fitting series number is 20592-xx-xx

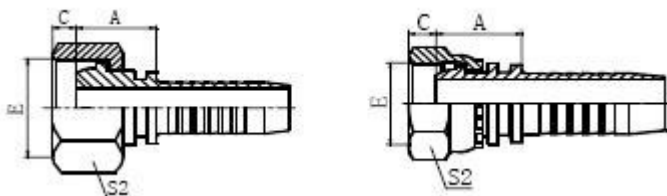

公制内螺纹 24°球面轻系列

METRIC FEMALE 24°MULTISEAL

L.T

ISO 12151-2--DIN 3865

20411C

20411C-T

代号 P/N	螺纹 E THREAD E	软管 HOSE BORE		管子外径 TUBE O.D	O 形圈 O RING	尺寸 DIMENSIONS			
		公称内径 DN	标号 DASH			A	C	S2	
20411C-12-04	M12X1.5	6	04	6		19.5	3.5	17	
20411C-14-04	M14X1.5	6	04	8		20.5	3.5	19	
20411C-16-04	M16X1.5	6	04	10		21	3.5	22	
20411C-16-05	M16X1.5	8	05	10		21	3.5	22	

20411C-16-06	M16X1.5	10	06	10		21	3.5	22	
20411C-18-06	M18X1.5	10	06	12		22.5	3	24	
20411C-22-06	M22X1.5	10	06	15		23.5	4.5	27	
20411C-22-08	M22X1.5	12	08	15		24	4.5	27	
20411C-26-10	M26X1.5	16	10	18		27	4	32	
20411C-30-10	M30X2	16	10	22		26.5	7	36	
20411C-30-12	M30X2	20	12	22		27	7	36	
20411C-30-14	M30X2	22	14	22		27	7	36	
20411C-36-16	M36X2	25	16	28		29	6.5	41	
20411C-36-18	M36X2	28	18	28		29	6.5	41	
20411C-45-20	M45X2	32	20	35		33	7	55	
20411C-52-24	M52X2	40	24	42		34	8	60	

Note: 1. For use with braided hoses.

2. If use with spiral hose, hose fitting series number is 20412C-xx-xx

90° 公制内螺纹 24°球面轻系列

90° METRIC FEMALE 24°MULTISEAL L.T

ISO 12151-2--DIN 3865

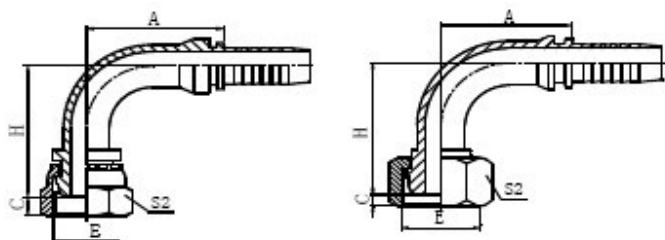

20491C

20491C-T

代号 P/N	螺纹 E THREAD E	软管 HOSE BORE		管子外径 TUBE O.D	O 形圈 O RING	尺寸 DIMENSION ;			
		公称内径 DN	标号 DASH			A	C	H	S2
20491C-14-04	M14X1.5	6	04	8		30	3.5	39.5	19
20491C-16-04	M16X1.5	6	04	10		30	3.5	40	22
20491C-16-05	M16X1.5	8	05	10		33	3.5	43	22
20491C-16-06	M16X1.5	10	06	10		35.25	3.5	45.2	22
20491C-18-06	M18X1.5	10	06	12		35.25	3	47.25	24
20491C-22-08	M22X1.5	12	08	15		41	4.5	53	27
20491C-26-10	M26X1.5	16	10	18		56.5	4	60	32
20491C-30-12	M30X2	20	12	22		65.5	7	68.5	36
20491C-30-14	M30X2	22	14	22		71.2	7	70	36
20491C-36-12	M36X2	20	12	28		65.5	6.5	67.5	41
20491C-36-18	M36X2	28	18	28		87.9	6.5	86.5	41

Note: 1. For use with braided hoses.

2. If use with spiral hose, hose fitting series number is 20412C-xx-xx

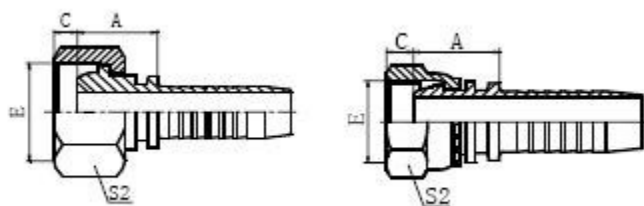

公制内螺纹 24°球面重系列

METRIC FEMALE 24°MULTISEAL

H.T

ISO 12151-2--DIN 3865

20511C

20511C-T

代号 P/N	螺纹 E THREAD E	软管 HOSE BORE		管子外径 TUBE O.D	O 形圈 O RING	尺寸 DIMENSIONS			
		公称内径 DN	标号 DASH			A	C	S2	
20511C-18-04	M18X1.5	6	04	10		21	3	22	
20511C-20-05	M20X1.5	8	05	12		21.5	4.5	24	
20511C-20-06	M20X1.5	10	06	12		21.5	4.5	24	
20511C-22-06	M22X1.5	10	06	14		21.5	4.5	27	
20511C-24-08	M24X1.5	12	08	16		23	5	30	
20511C-30-10	M30X2	16	10	20		26.5	7	36	
20511C-30-12	M30X2	20	12	20		27.5	7	36	
20511C-36-12	M36X2	20	12	25		27	6.5	41	
20511C-42-16	M42X2	25	16	30		29.5	9	50	
20511C-52-20	M52X2	32	20	38		34	8	60	

Note: 1. For use with braided hoses.

2. If use with spiral hose, hose fitting series number is 20512C-xx-xx

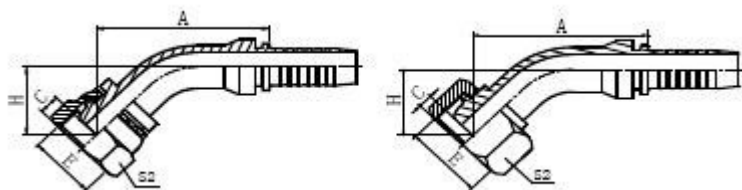

45° 公制内螺纹 24°球面重系列

45° METRIC FEMALE 24°MULTISEAL H.T

ISO 12151-2--DIN 3865

20541C

20541C-T

代号 P/N	螺纹 E THREAD E	软管 HOSE BORE		管子外径 TUBE O.D	O 形圈 O RING	尺寸 DIMENSIONS			
		公称内径 DN	标号 DASH			A	C	H	S2
20541C-16-04	M16X1.5	6	04	8		44.8	3	22.7	19
20541C-18-04	M18X1.5	6	04	10		43.7	3	21.6	22
20541C-20-06	M20X1.5	10	06	12		48.9	4.5	24.6	24
20541C-24-08	M24X1.5	12	08	16		61.4	2.5	26.5	30

Note: 1. For use with braided hoses.

2. If use with spiral hose, hose fitting series number is 20542C-xx-xx

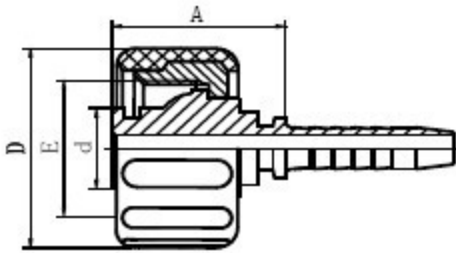

20011 公制内螺纹高压水管

METRIC FEMALE WATERWASH INSERT

代号 P/N	螺纹 E THREAD E	软管 HOSE BORE		管子外径 TUBE O.D	O 形圈 O RING	尺寸 DIMENSIONS		
		公称内径 DN	标号 DASH			A	d	D
20011-22-04T	M22X1.5	6	04			28	14	34.
20011-22-05T	M22X1.5	8	05			27.9	14	34.
20011-22-06T	M22X1.5	10	06			28	14	34.

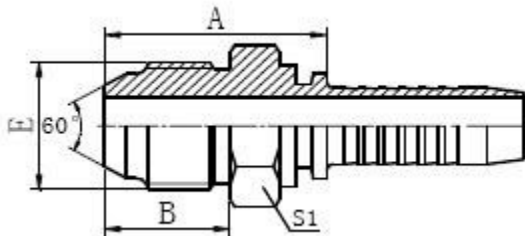

18611

日本公制外螺纹 60° 内锥面

JIS METRIC MALE 60° CONE SEAT

代号 P/N	螺纹 E THREAD E	软管 HOSE BORE		管子外径 TUBE O.D	O 形圈 O RING	尺寸 DIMENSIONS		
		公称内径 DN	标号 DASH			A	C	S1
18611-14-04	M14X1.5	6	04			29.5	17	17
18611-14-06	M14X1.5	10	06			29.5	17	17
18611-16-04	M16X1.5	6	04			30.5	18	17

18611-16-06	M16X1.5	10	06			30.5	18	17	
18611-18-06	M18X1.5	10	06			30.5	18	19	
18611-20-08	M20X1.5	12	08			35	20	22	
18611-22-08	M22X1.5	12	08			35	20	24	
18611-24-10	M24X1.5	16	10			39.5	21.5	27	
18611-30-12	M30X1.5	20	12			45	26	32	
18611-33-16	M33X1.5	25	16			50.5	30	36	
18611-36-20	M36X1.5	32	20			55	33	38	
18611-42-24	M42X1.5	40	24			60	36	46	

Note: 1. For use with braided hoses.

2. If use with spiral hose, hose fitting series number is 18612-xx-xx

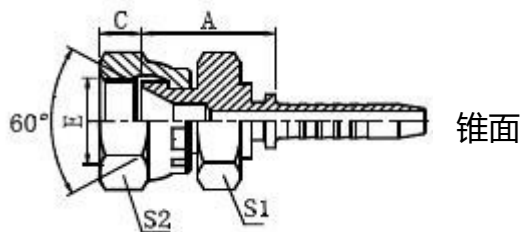

28611 日本公制内螺纹 60° 内

JIS METRIC FEMALE 60° CONE SEAT

代号 P/N	螺纹 E THREAD E	软管 HOSE BORE		管子外径 TUBE O.D	O 形圈 O RING	尺寸 DIMENSIONS			
		公称内径 DN	标号 DASH			A	C	S1	S2
28611-14-04	M14X1.5	6	04			21	10.5	19	19
28611-14-06	M14X1.5	10	06			21	10.5	19	19
28611-16-04	M16X1.5	6	04			24	10	22	22
28611-16-06	M16X1.5	10	06			24	10	22	22
28611-18-06	M18X1.5	10	06			25	11.5	24	24
28611-20-08	M20X1.5	12	08			28.5	12	27	27
28611-22-08	M22X1.5	12	08			25.5	14	27	27
28611-24-10	M24X1.5	16	10			28.5	15	32	32
28611-30-12	M30X1.5	20	12			28.5	18.3	36	36
28611-33-16	M33X1.5	25	16			32	21.3	41	41
28611-36-20	M36X1.5	32	20			35.5	20	46	46
28611-42-24	M42X1.5	40	24			36	18.8	55	55

Note: 1. For use with braided hoses.

2. If use with spiral hose, hose fitting series number is 28612-xx-xx

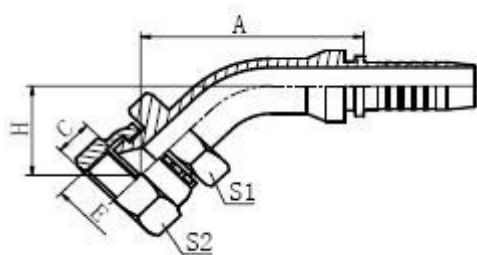

28641

45° 日本公制内螺纹 60° 内锥面

45° JIS METRIC FEMALE 60° CONE SEAT

代号 P/N	螺纹 E THREAD E	软管 HOSE BORE		管子外径 TUBE O.D	O 形圈 O RING	尺寸 DIMENSIONS			
		公称内径 DN	标号 DASH			A	C	S1	S2
28641-14-04	M14X1.5	6	04			21	10.5	19	19
28641-14-06	M14X1.5	10	06			21	10.5	19	19
28641-16-04	M16X1.5	6	04			24	10	22	22
28641-16-06	M16X1.5	10	06			24	10	22	22
28641-18-06	M18X1.5	10	06			25	11.5	24	24
28641-20-08	M20X1.5	12	08			28.5	12	27	27
28641-22-08	M22X1.5	12	08			25.5	14	27	27
28641-24-10	M24X1.5	16	10			28.5	15	32	32
28641-30-12	M30X1.5	20	12			28.5	18.3	36	36
28641-33-16	M33X1.5	25	16			32	21.3	41	41
28641-36-20	M36X1.5	32	20			35.5	20	46	46
28641-42-24	M42X1.5	40	24			36	18.8	55	55

Note: 1. For use with braided hoses.

2. If use with spiral hose, hose fitting series number is 28612-xx-xx

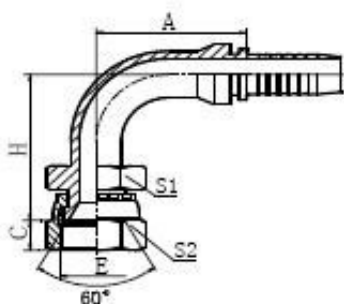

28691

90° 日本公制内螺纹 60° 内锥面

90° JIS METRIC FEMALE 60° CONE SEAT

代号 P/N	螺纹 E THREAD E	软管 HOSE BORE		管子外径 TUBE O.D	尺寸 DIMENSIONS				
		公称内径 DN	标号 DASH		A	C	H	S1	S2
28641-14-04	M14X1.5	6	04	30	10.5	38	19	19	
28641-14-06	M14X1.5	10	06	35.5	10.5	43.3	19	19	
28641-16-05	M16X1.5	8	05	33	10	44	22	22	
28641-18-06	M18X1.5	10	06	35.3	11.5	46.3	24	24	
28641-22-08	M22X1.5	12	08	41	14	52.5	27	27	
28641-24-10	M24X1.5	16	10	56.5	15	59	32	32	
28641-30-12	M30X1.5	20	12	65.5	18.3	68.5	36	36	
28641-33-16	M33X1.5	25	16	76.7	21.3	76	41	41	
28641-36-20	M36X1.5	32	20	93	20	90	46	46	
28641-42-24	M42X1.5	40	24	109.4	18.8	103	55	55	

Note: 1. For use with braided hoses.

2. If use with spiral hose, hose fitting series number is 28692-xx-xx

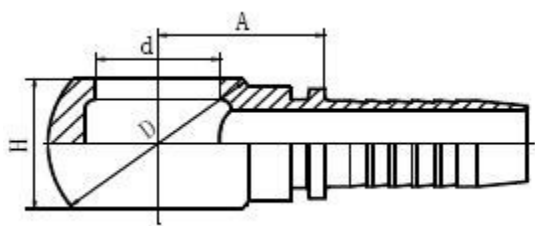

70011 公制铰接头

METRIC BANJO DIN 7642

代号 P/N	螺纹 E THREAD E	软管 HOSE BORE		管子外径 TUBE O.D	尺寸 DIMENSIONS			
		公称内径 DN	标号 DASH		A	d	D	H
70011-12-04	M12X1.5	6	04		20.5	12	20	12
70011-12-05	M12X1.5	8	05		20.5	12	20	12
70011-12-06	M12X1.5	10	06		20.5	12	20	12
70011-14-04	M14X1.5	6	04		21	14	24	14
70011-14-05	M14X1.5	8	05		21	14	24	14
70011-14-06	M14X1.5	10	06		21	14	24	14
70011-16-04	M16X1.5	6	04		20.5	16	28	16
70011-16-05	M16X1.5	8	05		20.5	16	28	16
70011-16-06	M16X1.5	10	06		20.5	16	28	16
70011-18-06	M18X1.5	10	06		24	18	32	20
70011-18-08	M18X1.5	12	08		24.5	18	32	20

70011-22-08	M22X1.5	12	08		28.5	22	39	25	
70011-22-10	M22X1.5	16	10		28	22	39	25	
70011-26-12	M26X1.5	20	12		32.5	26.2	46	30	
70011-30-16	M30X1.5	25	16		37	30.2	54	36	
70011-30-20	M30X1.5	32	20		40	30.2	54	36	

Note: 1. For use with braided hoses.

2. If use with spiral hose, hose fitting series number is 70012-xx-xx

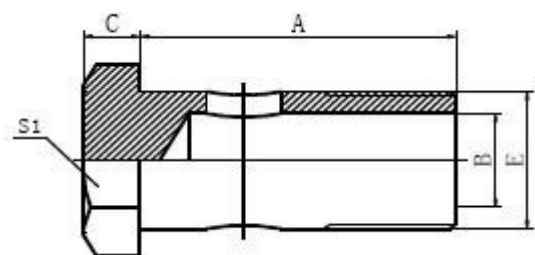

700M 公制铰螺栓

METRIC BOLT DIN 7643

代号 P/N	螺纹 E THREAD E	软管 HOSE BORE		管子外径 TUBE O.D	尺寸 DIMENSIONS				
		公称内径 DN	标号 DASH		A	B	C	S1	
700M-12	M12X1.5				24	6	6	17	
700M-14	M14X1.5				26	8	7	19	
700M-16	M16X1.5				28	9	7.5	22	
700M-18	M18X1.5				32	11	8	24	
700M-22	M22X1.5				39	14	9	27	
700M-26	M26X1.5				45	18	10	32	
700M-30	M30X1.5				51	22	11	38	

50011

公制式卡套式直管

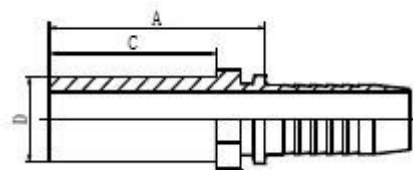

METRIC STANDPIPE STRAIGHT DIN 2553

代号 P/N	螺纹 E THREAD E	软管 HOSE BORE		尺寸 DIMENSIONS		备注 NOTE	
		公称内径 DN	标号 DASH	A	C		
50011-06-03	6	05	03	28.5	22	L.T	
50011-06-04	6	6	04	29	22		
50011-10-05	10	8	05	31	23		
50011-10-06	10	10	06	32	23		
50011-12-06	12	10	06	33.5	23		
50011-12-08	12	12	08	33	23		
50011-15-06	15	10	06	35.5	25		
50011-15-08	15	12	08	35.5	25		
50011-18-08	18	12	08	36.5	26		
50011-18-10	18	16	10	41	26		
50011-22-10	22	16	10	44	28		
50011-22-12	22	20	12	44	28		
50011-22-16	22	25	16	46	28		
50011-28-16	28	25	16	47	30		
50011-35-20	35	32	20	56	36		
50011-42-24	42	40	24	62	40		
50011-08-04	8	6	04	31	24		HT
50011-08-05	8	8	05	33	24		
50011-08-06	8	10	06	33	24		
50011-10-04	10	6	04	35	26		
50011-12-04	12	06	04	34.5	26		
50011-12-05	12	8	05	35.5	26		

50011-14-06	14	10	06	39.5	29	HT
50011-14-08	14	12	08	40	29	
50011-14-12	14	20	12	45.5	29	
50011-16-08	16	12	08	41	30	
50011-16-10	16	16	10	45.5	30	
50011-20-10	20	16	10	52.5	36	
50011-20-12	20	20	12	52.5	36	
50011-25-12	25	20	12	56	40	
50011-25-16	25	25	16	57	40	
50011-30-16	30	25	16	63	44	
50011-30-20	30	32	20	64	44	
50011-38-16	38	25	16	69	50	
50011-38-20	38	32	20	70	50	

Note: 1. For use with braided hoses.

2. If use with spiral hose, hose fitting series number is 50012-xx-xx

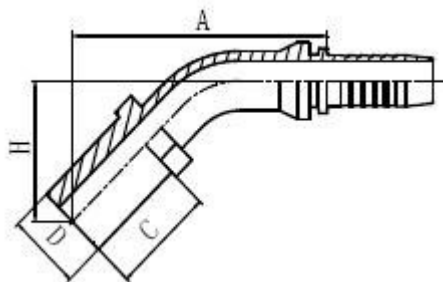

50041

45° 公制式卡套式直管

45° METRIC STANDPIPE STRAIGHT DIN 2553

代号 P/N	螺纹 E THREAD E	软管 HOSE BORE		尺寸 DIMENSIONS			备注 NOTE
		公称内径 DN	标号 DASH	A	C	H	
50041-06-03	6	05	03	47.8	22	27.5	L.T
50041-06-04	6	6	04	52.5	22	30.1	
50041-10-05	10	8	05	54	23	30.6	
50041-10-06	10	10	06	56.1	23	31.3	
50041-12-06	12	10	06	58.5	23	34.5	

50041-12-08	12	12	08	72.4	23	37.4	
50041-15-06	15	10	06	59.3	25	34.5	
50041-15-08	15	12	08	70.6	25	35.7	
50041-18-08	18	12	08	73.4	26	38.5	
50041-18-10	18	16	10	84.6	26	39.8	
50041-22-10	22	16	10	87.1	28	42.3	
50041-22-12	22	20	12	93.3	28	45.9	
50041-22-16	22	25	16	100.9	28	46.7	
50041-28-16	28	25	16	103.7	30	49.5	
50041-35-20	35	32	20	118.5	36	57.8	
50041-08-04	8	6	04	53.6	24	31.5	
50041-10-04	10	6	04	54	26	31.9	
50041-12-04	12	06	04	57.1	26	35.1	
50041-12-05	12	8	05	59.2	26	35.9	
50041-14-06	14	10	06	61.6	29	37.3	
50041-14-08	14	12	08	73.8	29	38.8	
50041-14-12	14	20	12	91.9	29	43.8	
50041-16-08	16	12	08	76.6	30	41.7	
50041-16-10	16	16	10	87.8	30	43	H.T
50041-20-10	20	16	10	92.8	36	48	
50041-20-12	20	20	12	100.7	36	52.6	
50041-25-12	25	20	12	101.8	40	54.4	
50041-25-16	25	25	16	109.4	40	55.2	
50041-30-16	30	25	16	113.6	44	59.4	
50041-30-20	30	32	20	124.2	44	63.5	
50041-38-16	38	25	16	117.9	50	63.6	
50041-38-20	38	32	20	128.4	50	67.7	

Note: 1. For use with braided hoses.

2. If use with spiral hose, hose fitting series number is 50042-xx-xx

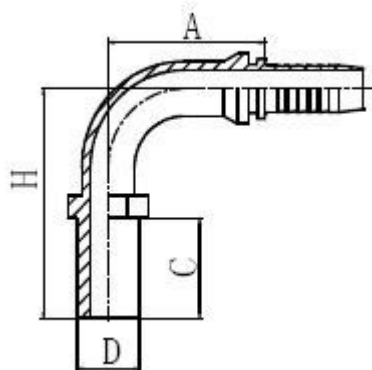

50091

90° 公制式卡套式直管

90° METRIC STANDPIPE STRAIGHT DIN 2553

代号 P/N	螺纹 E THREAD E	软管 HOSE BORE		尺寸 DIMENSIONS			备注 NOTE
		公称内径 DN	标号 DASH	A	C	H	
50091-06-03	6	05	03	26.5	22	45	L.T
50091-06-04	6	6	04	30	22	48	
50091-10-05	10	8	05	34	23	53	
50091-10-06	10	10	06	35.3	23	55.3	
50091-12-06	12	10	06	35.3	23	59.8	
50091-12-08	12	12	08	41	23	67	
50091-15-06	15	10	06	35.8	25	59.8	
50091-15-08	15	12	08	41	25	65	
50091-18-08	18	12	08	41	26	68.5	
50091-18-10	18	16	10	56.5	26	73	
50091-22-10	22	16	10	56.5	28	76.5	
50091-22-12	22	20	12	65.5	28	86	
50091-22-16	22	25	16	76.7	28	91.5	
50091-28-16	28	25	16	76.7	30	95.5	
50091-35-20	35	32	20	91.5	36	112.5	
50091-08-04	8	6	04	30	24	52.5	
50091-10-04	10	6	04	30	26	53	

50091-12-04	12	06	04	30	26	57.5
50091-12-05	12	8	05	33	26	60.5
50091-14-06	14	10	06	35.3	29	63.8
50091-14-08	14	12	08	41	29	69
50091-14-12	14	20	12	66.2	29	83
50091-16-08	16	12	08	42	30	73
50091-16-10	16	16	10	56.5	30	77.5
50091-20-10	20	16	10	56.5	36	84.5
50091-20-12	20	20	12	65.5	36	95.5
50091-25-12	25	20	12	65.5	40	98
50091-25-16	25	25	16	76.7	40	103.5
50091-30-16	30	25	16	78	40	109.5
50091-30-20	30	32	20	91.5	44	120.5
50091-38-16	38	25	16	76.7	50	115.5
50091-38-20	38	32	20	91.5	50	126.5

Note: 1. For use with braided hoses.

2. If use with spiral hose, hose fitting series number is 50092-xx-xx

NOTES

The drawings in this catalogue are for reference only, and their dimensions and proportions may be a little different from those of the real products.

Products included in this catalogue don't refer to all, so if customers are interested in other products, please don't hesitate to contact our company for further information.

Our company has made much effort to record the correct data in this publication. However, in order to promote our products, we may make some changes of their size or description, which haven't been shown yet. We reserve the rights for explanation, but sorry for no further notice to

customer the change of products' design, description or even stop of some products' manufacture in future.